

Basics of Measuring the Dielectric Properties of Materials

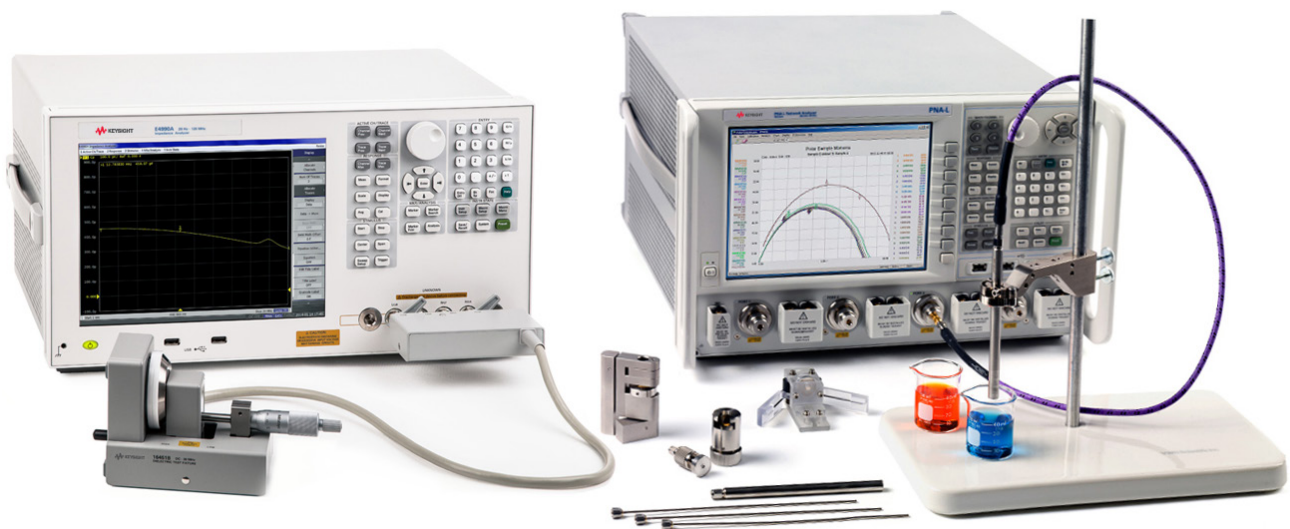

Table of Contents

Introduction.....	3
Dielectric Theory	5
Dielectric constant.....	5
Permeability.....	7
Electromagnetic Wave Propagation	9
Dielectric Mechanisms	11
Orientation (dipolar) polarization	12
Electronic and atomic polarization	12
Relaxation time.....	13
Debye relation	14
Cole-Cole diagram.....	14
Ionic conductivity.....	15
Interfacial or space charge polarization	15
Network analyzers	16
Impedance analyzers and LCR meters	17
Fixtures	18
Software.....	18
Measurement Techniques.....	18
Coaxial probe	18
Transmission line	21
Free space	24
Resonant cavity	27
Cavity perturbation (ASTM D2520).....	29
Parallel plate.....	30
Inductance measurement method.....	31
Comparison of Methods.....	32
Keysight Solutions	33
References.....	34

Introduction

A wide variety of industries need a better understanding of the materials they are working with to shorten design cycles, improve incoming inspection, process monitoring, and quality assurance. Every material has a unique set of electrical characteristics that are dependent on its dielectric properties. Accurate measurements of these properties can provide scientists and engineers with valuable information to properly incorporate the material into its intended application for more solid designs or to monitor a manufacturing process for improved quality control.

A dielectric materials measurement can provide critical design parameter information for many electronics applications. For example, the loss of a cable insulator, the impedance of a substrate, or the frequency of a dielectric resonator can be related to its dielectric properties. The information is also useful for improving ferrite, absorber and packaging designs. More recent applications in the area of aerospace, automotive, food and medical industries have also been found to benefit from knowledge of dielectric properties.

Keysight Technologies, Inc. offers a variety of instruments, fixtures, and software to measure the dielectric properties of materials. Keysight measurement instruments, such as network analyzers, impedance analyzers and LCR meters range in frequency up to 1.1 THz. Fixtures to hold the material under test (MUT) are available that are based on coaxial probe, parallel plate, coaxial/waveguide transmission lines, free space and resonant cavity methods. The table below shows product examples that can be measured by Keysight's material test solutions.

Table 1. Materials measurement applications example

Industry	Applications/Products
Electronics	Capacitor, substrates, PCB, PCB antenna, ferrites, magnetic recording heads, absorbers, SAR phantom materials, sensor
Aerospace/ Defense	Stealth, RAM (Radiation Absorbing Materials), radomes
Industrial materials	Ceramics and composites: IC package, aerospace and automotive components, cement, coatings, bio-implants
	Polymers and plastics: fibers, substrates, films, insulation materials
	Hydrogel: disposable diaper, soft contact lens
	Liquid crystal: displays
	Rubber, semiconductors and superconductors
	Other products containing these materials: tires, paint, adhesives, etc.
Food & Agriculture	Food preservation (spoilage) research, food development for microwave, packaging, moisture measurements
Forestry & Mining	Moisture measurements in wood or paper, oil content analysis
Pharmaceutical & Medical	Drug research and manufacturing, bio-implants, human tissue characterization, biomass, chemical concentration, fermentation
<p><i>Note: There are other measurement methods for characterizing materials such as resistivity and conductivity measurements. Refer to the Keysight Application Note 5992-1182EN for more detail information¹⁶.</i></p>	

Dielectric Theory

The material properties that will be discussed here are permittivity and permeability. Resistivity is another material property which will not be discussed here. Information about resistivity and its measurement can be found in the *Solutions for Measuring Permittivity and Permeability with LCR Meters and Impedance Analyzers* application note. It is important to note that permittivity and permeability are not constant. They can change with frequency, temperature, orientation, mixture, pressure, and molecular structure of the material.

Dielectric constant

A material is classified as “dielectric” if it has the ability to store energy when an external electric field is applied. If a DC voltage source is placed across a parallel plate capacitor, more charge is stored when a dielectric material is between the plates than if no material (a vacuum) is between the plates. The dielectric material increases the storage capacity of the capacitor by neutralizing charges at the electrodes, which ordinarily would contribute to the external field. The capacitance with the dielectric material is related to dielectric constant. If a DC voltage source V is placed across a parallel plate capacitor (Figure 1), more charge is stored when a dielectric material is between the plates than if no material (a vacuum) is between the plates.

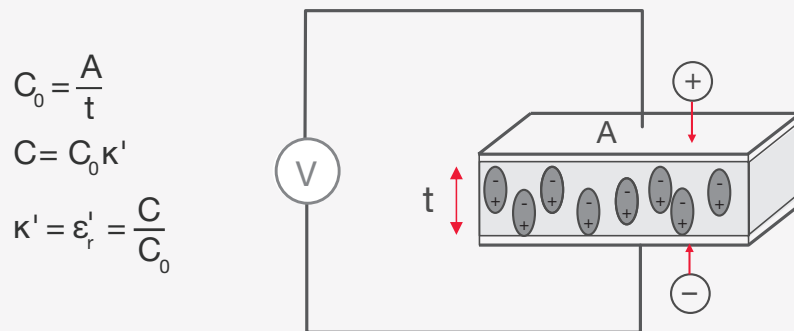

Figure 1. Parallel plate capacitor, DC case.

Where C and C_0 are capacitance with and without dielectric, $\kappa' = \epsilon'_r$ is the real dielectric constant or permittivity, and A and t are the area of the capacitor plates and the distance between them (Figure 1). The dielectric material increases the storage capacity of the capacitor by neutralizing charges at the electrodes, which ordinarily would contribute to the external field. The capacitance of the dielectric material is related to the dielectric constant as indicated in the above equations. If an AC sinusoidal voltage source V is placed across the same capacitor (Figure 2), the resulting current will be made up of a charging current I_c and a loss current I_l

that is related to the dielectric constant. The losses in the material can be represented as a conductance (G) in parallel with a capacitor (C).

$$I = I^C + I^G = V(j\omega C_0 K' + G)$$

If $G = \omega C_0 K''$, then

$$I = V(j\omega C_0) K' - jK'' = V(j\omega C_0) K$$

$$\omega = 2\pi f$$

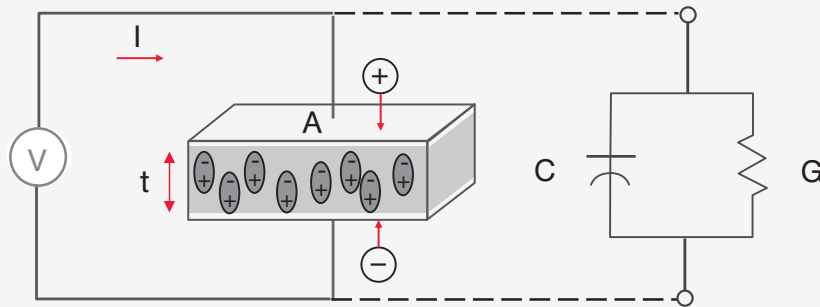

Figure 2. Parallel plate capacitor, AC case.

The complex dielectric constant k consists of a real part κ' which represents the storage and an imaginary part κ'' which represents the loss. The following notations are used for the complex dielectric constant interchangeably $\kappa = \kappa^* = \epsilon_r = \epsilon_r^*$.

From the point of view of electromagnetic theory, the definition of electric displacement

$$D_f = \epsilon E$$

(electric flux density) D_f is:

where $\epsilon = \epsilon^* = \epsilon_0 \epsilon_r$ is the absolute permittivity (or permittivity), ϵ_r is the relative permittivity, $\epsilon_0 \approx \frac{1}{36\pi} \times 10^{-9}$ F/m is the free space permittivity and E is the electric field.

Permittivity describes the interaction of a material with an electric field E and is a

$$K = \frac{\epsilon}{\epsilon_0} = \epsilon_r = \epsilon_r' - j \epsilon_r''$$

complex quantity.

Dielectric constant (k) is equivalent to relative permittivity (ϵ_r) or the absolute permittivity (ϵ) relative to the permittivity of free space (ϵ_0). The real part of permittivity (ϵ_r') is a measure of how much energy from an external electric field is stored in a material. The imaginary part of permittivity (ϵ_r'') is called the loss factor and is a measure of how dissipative or lossy a material is to an external electric field. The imaginary part of permittivity (ϵ_r'') is always greater than zero and is usually much smaller than (ϵ_r'). The loss factor includes the effects of both dielectric loss and conductivity.

When complex permittivity is drawn as a simple vector diagram (Figure 3), the real and imaginary components are 90° out of phase. The vector sum forms an angle δ with the real axis (ϵ_r'). The relative “lossiness” of a material is the ratio of the energy lost to the energy stored.

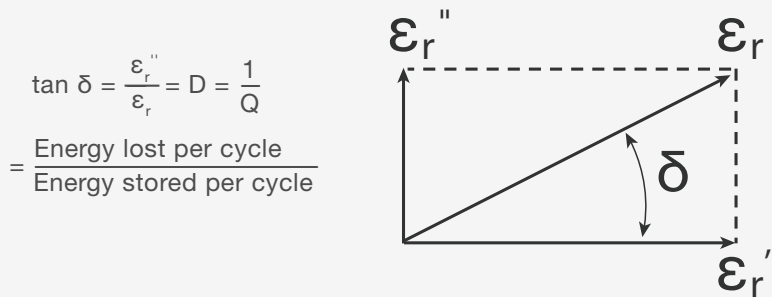

Figure 3. Loss tangent vector diagram.

The loss tangent or $\tan \delta$ is defined as the ratio of the imaginary part of the dielectric constant to the real part. D denotes dissipation factor and Q is quality factor. The loss tangent $\tan \delta$ is called $\tan \delta$, tangent loss or dissipation factor. Sometimes the term “quality factor or Q-factor” is used with respect to an electronic microwave material, which is the reciprocal of the loss tangent. For very low loss materials, since $\tan \delta \approx \delta$, the loss tangent can be expressed in angle units, milliradians or microradians.

Permeability

Permeability (μ) describes the interaction of a material with a magnetic field. A similar analysis can be performed for permeability using an inductor with resistance to represent core losses in a magnetic material (Figure 4). If a DC current source is placed across an inductor, the inductance with the core material can be related to permeability.

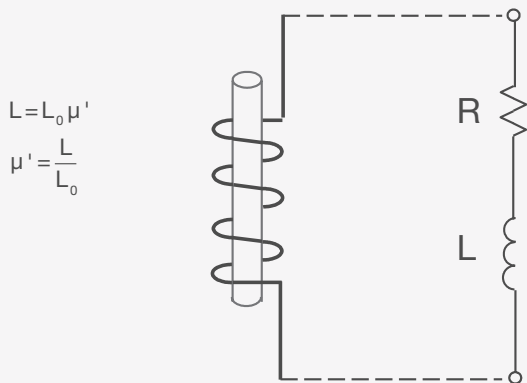

Figure 4. Inductor.

In the equations L is the inductance with the material, L_0 is free space inductance of the coil and μ' is the real permeability. If an AC sinusoidal current source is placed across the same inductor, the resulting voltage will be made up of an induced voltage and a loss voltage that is related to permeability. The core loss can be represented by a resistance (R) in series with an inductor (L). The complex permeability (μ^* or μ) consists of a real part (μ') that represents the energy storage term and an imaginary part (μ'') that represents the energy loss term. Relative permittivity μ_r is the permittivity relative to free space:

$$\mu_r = \frac{m}{m_0} = \mu_r - j\mu_r''$$

$\mu_0 = 4\pi \times 10^{-7}$ H/m is the free space permeability

Some materials such as iron (ferrites), cobalt, nickel, and their alloys have appreciable magnetic properties; however, many materials are nonmagnetic, making the permeability very close to the permeability of free space ($\mu_r = 1$). All materials, on the other hand, have dielectric properties, so the focus of this discussion will mostly be on permittivity measurements.

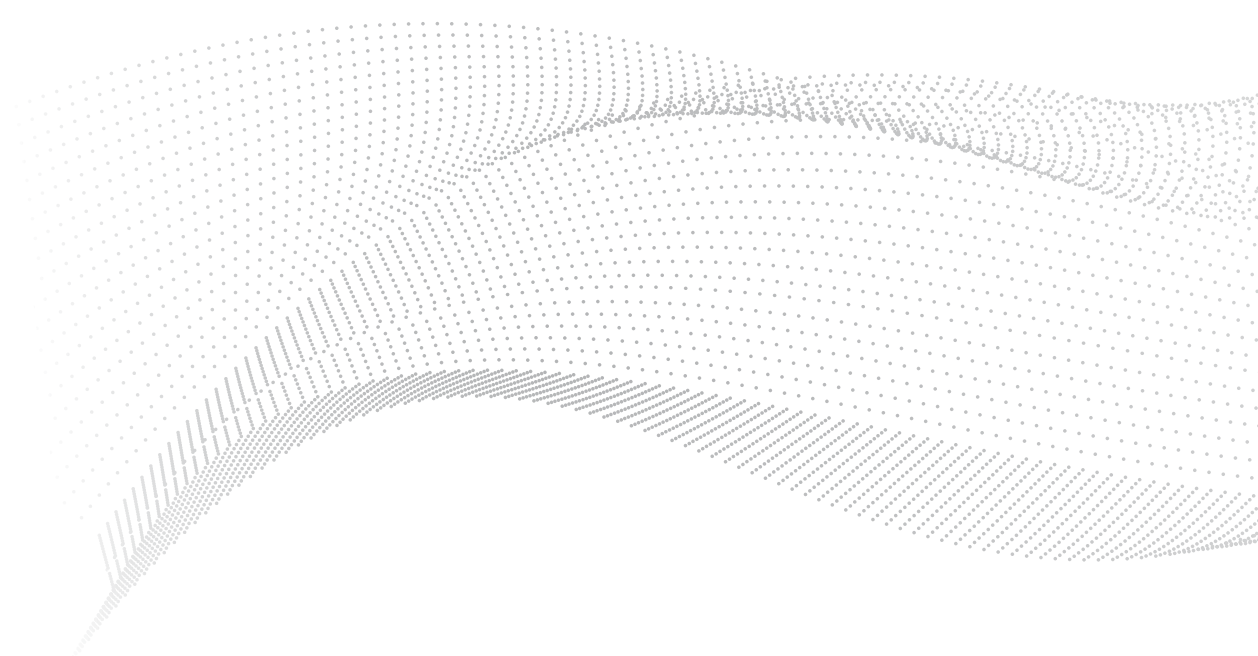

Electromagnetic Wave Propagation

In the time-varying case (i.e., a sinusoid), electric fields and magnetic fields appear together. This electromagnetic wave can propagate through free space (at the speed of light, $c = 3 \times 10^8$ m/s) or through materials at slower speed. Electromagnetic waves of various wavelengths exist. The wavelength λ of a signal is inversely proportional to its frequency f ($\lambda = c/f$), such that as the frequency increases, the wavelength decreases. For example, in free space a 10 MHz signal has a wavelength of 30 m, while at 10 GHz it is just 3 cm. Many aspects of wave propagation are dependent on the permittivity and permeability of a material. Let's use the "optical view" of dielectric behavior. Consider a flat slab of material (MUT) in space, with a TEM wave incident on its surface (Figure 5). There will be incident, reflected and transmitted waves. Since the impedance of the wave in the material Z is different (lower) from the free space impedance η (or Z_0) there will be impedance mismatch and this will create the reflected wave. Part of the energy will penetrate the sample. Once in the slab, the wave velocity v , is slower than the speed of light c . The wavelength λ_d is shorter than the wavelength λ_0 in free space according to the equations below. Since the material will always have some loss, there will be attenuation or insertion loss. For simplicity the mismatch on the second border is not considered.



Figure 5. Reflected and transmitted signals.

Figure 6 depicts the relation between the dielectric constant of the Material Under Test (MUT) and the reflection coefficient $|\Gamma|$ for an infinitely long sample (no reflection from the back of the sample is considered). For small values of the dielectric constant (approximately less than 20), there is a lot of change of the reflection coefficient for a small change of the dielectric constant. In this range dielectric constant measurement using the reflection coefficient will be more sensitive and hence precise. Conversely, for high dielectric constants (for example between 70 and 90) there will be little change of the reflection coefficient and the measurement will have more uncertainty.

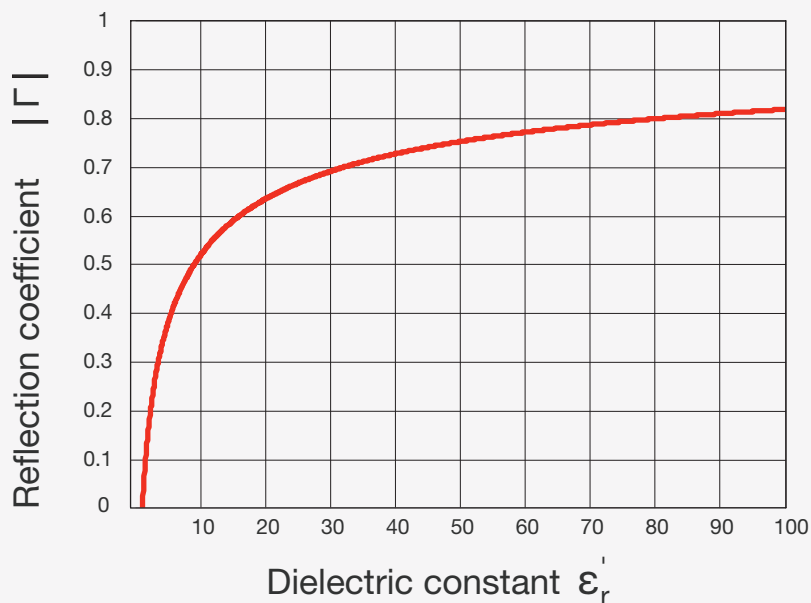

Figure 6. Reflection coefficient versus dielectric constant.

Dielectric Mechanisms

A material may have several dielectric mechanisms or polarization effects that contribute to its overall permittivity (Figure 7). A dielectric material has an arrangement of electric charge carriers that can be displaced by an electric field. The charges become polarized to compensate for the electric field such that the positive and negative charges move in opposite directions.

At the microscopic level, several dielectric mechanisms can contribute to dielectric behavior. Dipole orientation and ionic conduction interact strongly at microwave frequencies. Water molecules, for example, are permanent dipoles, which rotate to follow an alternating electric field. These mechanisms are quite lossy – which explains why food heats in a microwave oven. Atomic and electronic mechanisms are relatively weak, and usually constant over the microwave region. Each dielectric mechanism has a characteristic “cutoff frequency.” As frequency increases, the slow mechanisms drop out in turn, leaving the faster ones to contribute to ϵ' . The loss factor (ϵ_r'') will correspondingly peak at each critical frequency. The magnitude and “cutoff frequency” of each mechanism is unique for different materials. Water has a strong dipolar effect at low frequencies – but its dielectric constant rolls off dramatically around 22 GHz. PTFE, on the other hand, has no dipolar mechanisms and its permittivity is remarkably constant well into the millimeter-wave region.

A resonant effect is usually associated with electronic or atomic polarization. A relaxation effect is usually associated with orientation polarization.

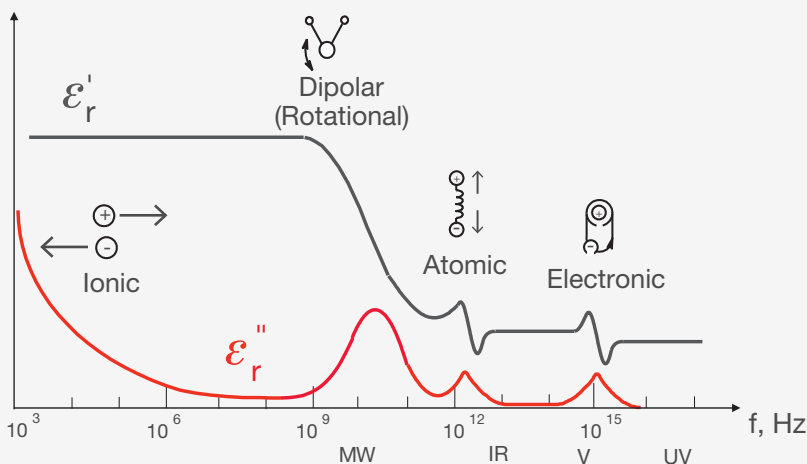

Figure 7. Frequency response of dielectric mechanisms.

Orientation (dipolar) polarization

A molecule is formed when atoms combine to share one or more of their electrons. This rearrangement of electrons may cause an imbalance in charge distribution creating a permanent dipole moment. These moments are oriented in a random manner in the absence of an electric field so that no polarization exists. The electric field E will exercise torque T on the electric dipole, and the dipole will rotate to align with the electric field causing orientation polarization to occur (Figure 8). If the field changes the direction, the torque will also change.

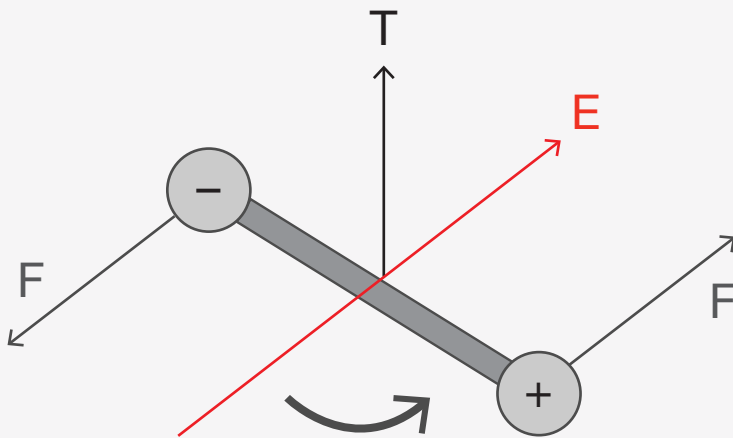

Figure 8. Dipole rotation in electric field.

The friction accompanying the orientation of the dipole will contribute to the dielectric losses. The dipole rotation causes a variation in both ϵ_r' and ϵ_r'' at the relaxation frequency which usually occurs in the microwave region. As mentioned, water is an example of a substance that exhibits a strong orientation polarization.

Electronic and atomic polarization

Electronic polarization occurs in neutral atoms when an electric field displaces the nucleus with respect to the electrons that surround it. Atomic polarization occurs when adjacent positive and negative ions “stretch” under an applied electric field. For many dry solids, these are the dominant polarization mechanisms at microwave frequencies, although the actual resonance occurs at a much higher frequency. In the infrared and visible light regions the inertia of the orbiting electrons must be taken into account. Atoms can be modeled as oscillators with a damping effect similar to a mechanical spring and mass system (Figure 7). The amplitude of the oscillations will be small for any frequency other than the resonant frequency. Far below resonance, the electronic and atomic mechanisms contribute only a small constant amount to ϵ_r' and are almost

lossless. The resonant frequency is identified by a resonant response in ϵ_r' and a peak of maximum absorption in ϵ_r'' . Above the resonance, the contribution from these mechanisms disappears.

Relaxation time

Relaxation time τ is a measure of the mobility of the molecules (dipoles) that exist in a material. It is the time required for a displaced system aligned in an electric field to return to 1/e of its random equilibrium value (or the time required for dipoles to become oriented in an electric field). Liquid and solid materials have molecules that are in a condensed state with limited freedom to move when an electric field is applied. Constant collisions cause internal friction so that the molecules turn slowly and exponentially approach the final state of orientation polarization with relaxation time constant τ .

$$t = \frac{1}{\omega_c} = \frac{1}{2\pi f_c}$$

When the field is switched off, the sequence is reversed and random distribution is restored with the same time constant. The relaxation frequency f_c is inversely related to relaxation time.

At frequencies below relaxation the alternating electric field is slow enough that the dipoles are able to keep pace with the field variations. Because the polarization is able to develop fully, the loss (ϵ_r'') is directly proportional to the frequency (Figure 9). As the frequency increases, ϵ_r'' continues to increase but the storage (ϵ_r') begins to decrease due to the phase lag between the dipole alignment and the electric field. Above the relaxation frequency both ϵ_r'' and ϵ_r' drop off as the electric field is too fast to influence the dipole rotation and the orientation polarization disappears.

Debye equation: $\epsilon(\omega) = \epsilon_\infty + \frac{\epsilon_s - \epsilon_\infty}{1 + j\omega\tau}$

For $\omega = 0$, $\epsilon(0) = \epsilon_s$

For $\omega = \infty$, $\epsilon(\infty) = \epsilon_\infty$

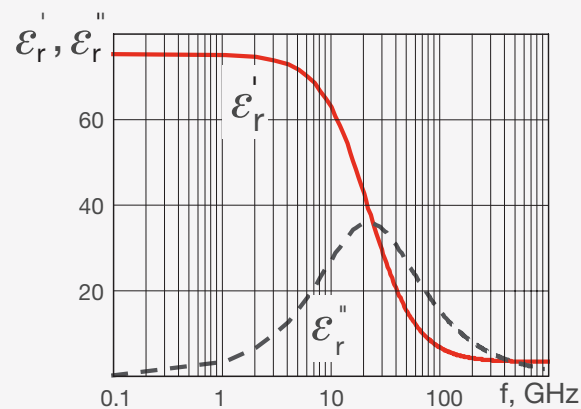

Figure 9. Debye relaxation of water at 30° C.

Debye relation

Materials that exhibit a single relaxation time constant can be modeled by the Debye relation, which appears as a characteristic response in permittivity as a function of frequency (Figure 9). ϵ_r' is constant above and below the relaxation with the transition occurring near the relaxation frequency (22 GHz). Additionally, ϵ_r'' is small above and below relaxation and peaks in the transition region at the relaxation frequency.

In calculating the above curves the static (DC) value of the dielectric constant is $\epsilon_s = 76.47$, the optical (infinite frequency) value of the dielectric constant is $\epsilon_\infty = 4.9$ and the relaxation time $\tau = 7.2$ ps.

Cole-Cole diagram

The complex permittivity may also be shown on a Cole-Cole diagram by plotting the imaginary part (ϵ_r'') on the vertical axis and the real part (ϵ_r') on the horizontal axis with frequency as the independent parameter (Figure 10). A Cole-Cole diagram is, to some extent, similar to the Smith chart. A material that has a single relaxation frequency as exhibited by the Debye relation will appear as a semicircle with its center lying on the horizontal $\epsilon_r'' = 0$ axis and the peak of the loss factor occurring at $1/\tau$. A material with multiple relaxation frequencies will be a semicircle (symmetric distribution) or an arc (nonsymmetrical distribution) with its center lying below the horizontal $\epsilon_r'' = 0$ axis.

The curve in Figure 10 is a half circle with its center on the x-axis and its radius $\frac{\epsilon_s - \epsilon_\infty}{2}$. The maximum imaginary part of the dielectric constant $\epsilon_r''_{\max}$ will be equal to the radius. The frequency moves counter clockwise on the curve.

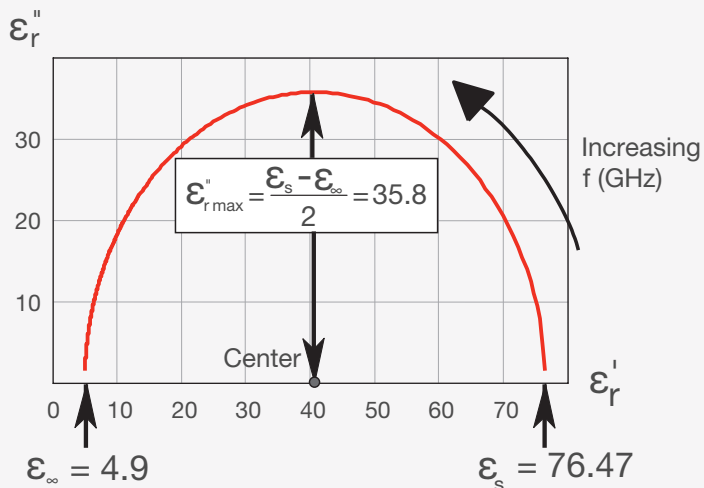

Figure 10. Cole-Cole diagram of Figure 9.

Ionic conductivity

The measured loss of material can actually be expressed as a function of both dielectric loss (ϵ_{rd}'') and conductivity (σ).

$$\epsilon_r'' = \epsilon_{rd}'' + \frac{\sigma}{\omega \epsilon_0}$$

At low frequencies, the overall conductivity can be made up of many different conduction mechanisms, but ionic conductivity is the most prevalent in moist materials. ϵ_r'' is dominated by the influence of electrolytic conduction caused by free ions which exist in the presence of a solvent (usually water). Ionic conductivity only introduces losses into a material. At low frequencies the effect of ionic conductivity is inversely proportional to frequency and appears as a 1/f slope of the ϵ_r'' curve.

Interfacial or space charge polarization

Electronic, atomic, and orientation polarization occur when charges are locally bound in atoms, molecules, or structures of solids or liquids. Charge carriers also exist that can migrate over a distance through the material when a low frequency electric field is applied. Interfacial or space charge polarization occurs when the motion of these migrating charges is impeded. The charges can become trapped within the interfaces of a material. Motion may also be impeded when charges cannot be freely discharged or replaced at the electrodes. The field distortion caused by the accumulation of these charges increases the overall capacitance of a material which appears as an increase in ϵ_r' .

Mixtures of materials with electrically conducting regions that are not in contact with each other (separated by non-conducting regions) exhibit the Maxwell-Wagner effect at low frequencies. If the charge layers are thin and much smaller than the particle dimensions, the charge responds independently of the charge on nearby particles. At low frequencies the charges have time to accumulate at the borders of the conducting regions causing ϵ_r' to increase. At higher frequencies the charges do not have time to accumulate and polarization does not occur since the charge displacement is small compared to the dimensions of the conducting region. As the frequency increases, ϵ_r' decreases and the losses exhibit the same 1/f slope as normal ionic conductivity.

Many other dielectric mechanisms can occur in this low frequency region causing a significant variation in permittivity. For example, colloidal suspension occurs if the charge layer is on the same order of thickness or larger than the particle dimensions. The Maxwell-Wagner effect is no longer applicable since the response is now affected by the charge distribution of adjacent particles.

Measurement System

Network analyzers

A measurement of the reflection from and/or transmission through a material along with knowledge of its physical dimensions provides the information to characterize the permittivity and permeability of the material. Vector network analyzers such as the PNA family, ENA series and FieldFox make swept high frequency stimulus-response measurements from 9 kHz to 1.1 THz. (Figure 12). A vector network analyzer consists of a signal source, a receiver and a display (Figure 11). The source launches a signal at a single frequency to the material under test. The receiver is tuned to that frequency to detect the reflected and transmitted signals from the material. The measured response produces the magnitude and phase data at that frequency. The source is then stepped to the next frequency and the measurement is repeated to display the reflection and transmission measurement response as a function of frequency. More information on the network analyzer functioning and architecture is in *Solutions for Measuring Permittivity and Permeability with LCR Meters and Impedance Analyzers and Understanding the Fundamental Principles of Vector Network Analysis* application notes.

Simple components and connecting wires that perform well at low frequencies behave differently at high frequencies. At microwave frequencies wavelengths become small compared to the physical dimensions of the devices such that two closely spaced points can have a significant phase difference. Low frequency lumped-circuit element techniques must be replaced by transmission line theory to analyze the behavior of devices at higher frequencies. Additional high frequency effects such as radiation loss, dielectric loss and capacitive coupling make microwave circuits more complex and expensive. It is time consuming and costly to try to design a perfect microwave network analyzer.

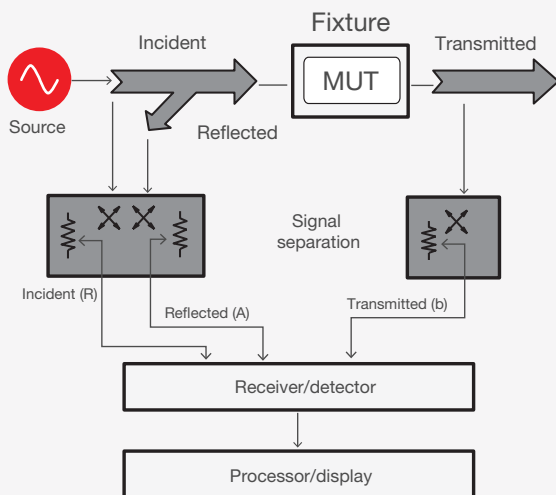

Figure 11. Network analyzer.

Instead, a measurement calibration is used to eliminate the systematic (stable and repeatable) measurement errors caused by the imperfections of the system. Random errors due to noise, drift, or the environment (temperature, humidity, pressure) cannot be removed with a measurement calibration. This makes a microwave measurement susceptible to errors from small changes in the measurement system. These errors can be minimized by adopting good measurement practices, such as visually inspecting all connectors for dirt or damage and by minimizing any physical movement of the test port cables after a calibration. More information on the network analyzer calibration is available in the *Exploring the Architectures of Network Analyzers* application note.⁴

Impedance analyzers and LCR meters

Impedance analyzers and LCR meters such as the ones listed in Figure 12 are used to measure the material properties at lower frequencies. The material is stimulated with an AC source and the actual voltage across the material is monitored. Material test parameters are derived by knowing the dimensions of the material and by measuring its capacitance and dissipation factor.

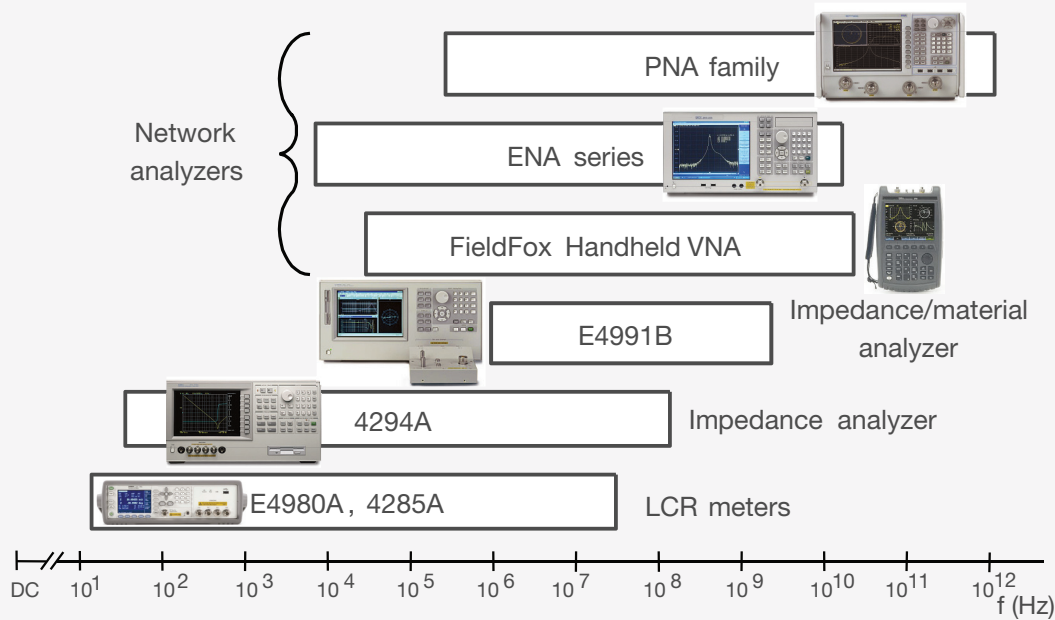

Figure 12. Frequency coverage of Keysight's instruments used for dielectric measurements.

Fixtures

Before the dielectric properties of a material can be measured with network analyzer, impedance analyzer, or LCR meter, a measurement fixture (or sample holder) is required to apply the electromagnetic fields in a predictable way and to allow connection to the measurement instrument. The type of fixture required will depend on the chosen measurement technique and the physical properties of the material (solid, liquid, powder, gas).

Software

The measured data from the instrument is not always presented in the most convenient terminology or format. In this case, software is required to convert the measured data to permittivity or permeability. Software may also be required to model any interaction between the fixture and MUT to allow the extraction of the bulk material properties.

Measurement Techniques

Coaxial probe

Method features

- Broadband
- Simple and convenient (non-destructive)
- Limited ϵ_r accuracy and $\tan \delta$ low loss resolution
- Best for liquids or semi-solids

Material assumptions

- “Semi-infinite” thickness
- Non-magnetic
- Isotropic and homogeneous
- Flat surface
- No air gaps

The open-ended coaxial probe is a cut off section of transmission line. The material is measured by immersing the probe into a liquid or touching it to the flat face of a solid (or powder) material. The fields at the probe end “fringe” into the material and change as they come into contact with the MUT (Figure 13). The reflected signal⁵ (S_{11}) can be measured and related to ϵ_r^* .

A typical measurement system using a coaxial probe method consists of a network analyzer or impedance analyzer, software to calculate permittivity, and a coaxial probe, probe stand and cable. The coaxial probe, probe stand and cable are available in

the N1501A dielectric probe kit. The software is now available in N1500A materials measurement suite. The software can be installed on an external PC and interfaced over GPIB, LAN or USB, depending on the analyzer. Or, with ENA or PNA series network analyzers, the software can be installed directly on the analyzer, eliminating the need for an external PC.

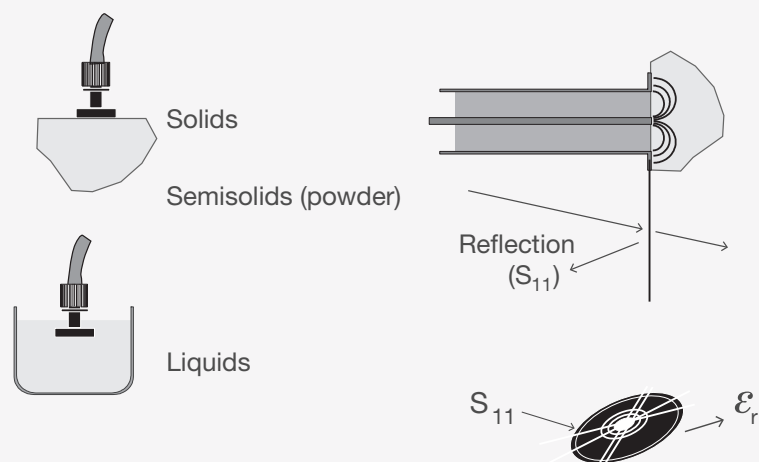

Figure 13. Coaxial probe method.

Figure 14 shows the three probes that are available in the N1501A kit; the high temperature probe (a), the slim form probe (b), and the performance probe (c). The high temperature probe (a) is shown with the shorting block to the right. Three slim probes are shown at the bottom of (b) with the short on the top and a couple of other accessories. The performance probe (c) is shown with the shorting block to the top.

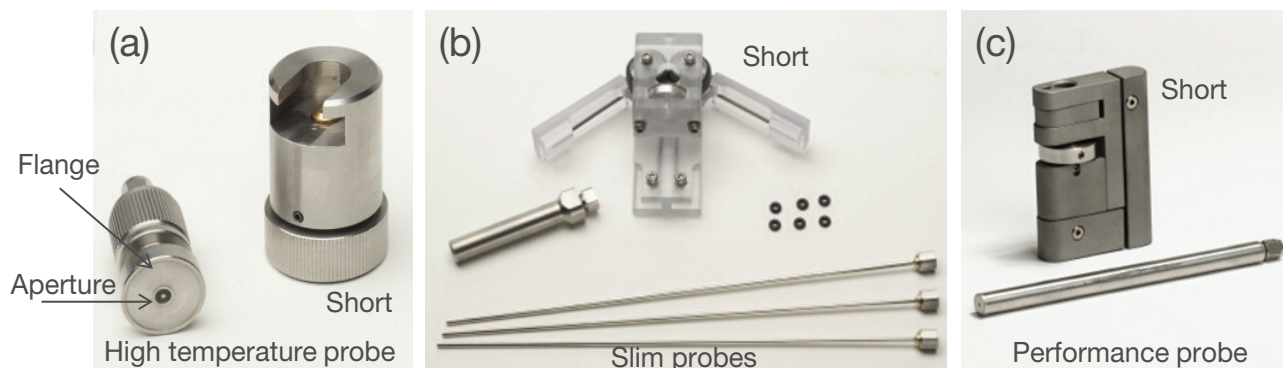

Figure 14. Three dielectric probe configurations.

Rugged in design, the high temperature probe (a) features a hermetic glass-to-metal seal, which makes it resistant to corrosive or abrasive chemicals. The probe withstands a wide -40 to $+200^\circ\text{C}$ temperature range, which allows measurements versus frequency

and temperature. The large flange allows measurements of flat surfaced solid materials, in addition to liquids and semi-solids. The slim form probe (b) features a slim design, which allows it to fit easily in fermentation tanks, chemical reaction chambers, or other equipment with small apertures. The slim design also allows it to be used with smaller sample sizes. This probe is best used for liquids and soft semi-solids. For castable solids, the probe is economical enough to be cast into the material and left in place. Because of the consumable nature of this design, these probes are offered in sets of three. The slim form probe kit comes with a sealed slim form holder that adapts a 2.2 mm outer diameter to 10 mm inner diameter bracket included in the kit as well as commercially available “Midi” sized adapters and bushings. The performance probe (c) combines rugged, high temperature and frequency performance in a slim design, perfect for your most demanding applications. The probe is sealed on both the probe tip and the connector end, which makes it our most rugged probe. The probe withstands a wide -40 to $+200^{\circ}\text{C}$ temperature range, which allows measurements versus frequency and temperature. The probe can be autoclaved, so it is perfect for applications in the food, medical, and chemical industries where sterilization is a must. The slim design allows it to fit easily in fermentation tanks, chemical reaction chambers, or other equipment with small apertures. It is useful for measuring liquid, semi-solid, as well as flat surfaced solid materials. Additional detailed information is available in the Dielectric Probe Technical Overview⁶ and Software Online Help⁷.

The dielectric probes are compatible with the Keysight network analyzers and the E4991B impedance analyzer. With the impedance analyzer the high temperature probe is specified from 10 MHz.

Before measuring, calibration at the tip of the probe must be performed. A three-term calibration corrects for the directivity, tracking, and source match errors that can be present in a reflection measurement. In order to solve for these three error terms, three well-known standards are measured. The difference between the predicted and actual values is used to remove the systematic (repeatable) errors from the measurement. The three known standards are air, a short circuit, and distillate and de-ionized water. Even after calibrating the probe, there are additional sources of error that can affect the accuracy of a measurement. There are three main sources of errors:

- Cable stability
- Air Gaps
- Sample thickness

It is important to allow enough time for the cable (that connects the probe to the network analyzer) to stabilize before making a measurement and to be sure that the cable is not flexed between calibration and measurement. The automated Electronic

Calibration Refresh feature recalibrates the system automatically, in seconds, just before each measurement is made. This virtually eliminates cable instability and system drift errors.

For solid materials, an air gap between the probe and sample can be a significant source of error unless the sample face is machined to be at least as flat as the probe face. For liquid samples air bubbles on the tip of the probe can act in the same way as an air gap on a solid sample.

The sample must also be thick enough to appear “infinite” to the probe. There is a simple equation⁶ to calculate the approximate thickness of the sample for the high temperature probe sample and suggested thickness for the slim probe sample. A simple practical approach is to put a short behind the sample and check to see if it affects the measurement results.

Figure 15 shows a comparison of measurements of dielectric constant and loss factor of methanol at room temperature (25°C) using the high temperature probe, with theoretical calculations using the Cole-Cole model. The following parameters are used in the Cole-Cole calculations:

$$\epsilon_s = 33.7, \epsilon_\infty = 4.45, \tau = 4.95 \times 10^{-11}, \alpha = 0.036$$

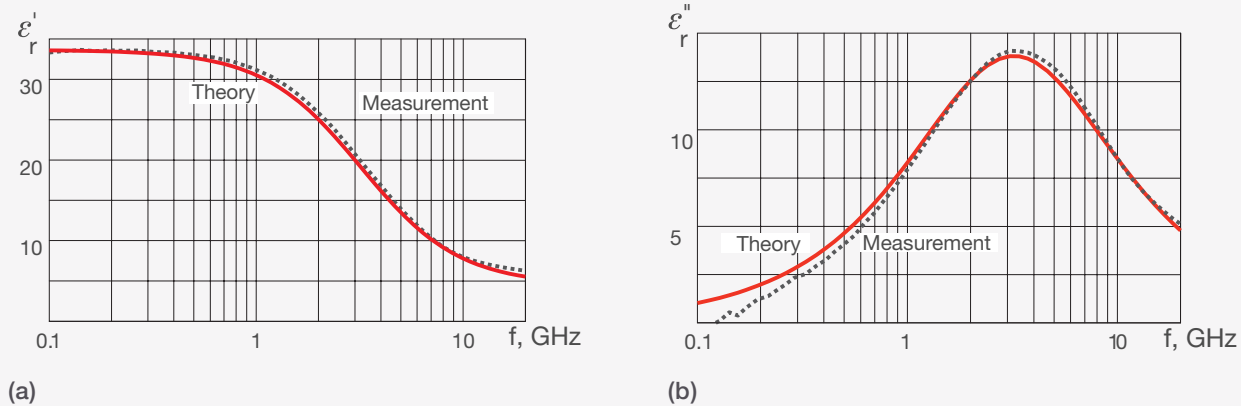

Figure 15. Measured dielectric constant (a) and loss factor (b) of methanol at 25 °C compared with Cole-Cole model.

A disadvantage of the coaxial probe method is limited accuracy under some conditions when compared to the transmission line, free space, or resonant cavity methods.

Transmission line

Transmission line methods involve placing the material inside a portion of an enclosed transmission line. The line is usually a section of rectangular waveguide or coaxial airline (Figure 16). ϵ_r^* and μ_r^* are computed from the measurement of the reflected signal (S_{11}) and transmitted signal (S_{21}).

Material assumptions

- Sample fills fixture cross section
- No air gaps at fixture walls
- Smooth, flat faces, perpendicular to long axis
- Homogeneous

Method features

- Broadband – low end limited by practical sample length
- Limited low loss resolution (depends on sample length)
- Measures magnetic materials
- Anisotropic materials can be measured in waveguide

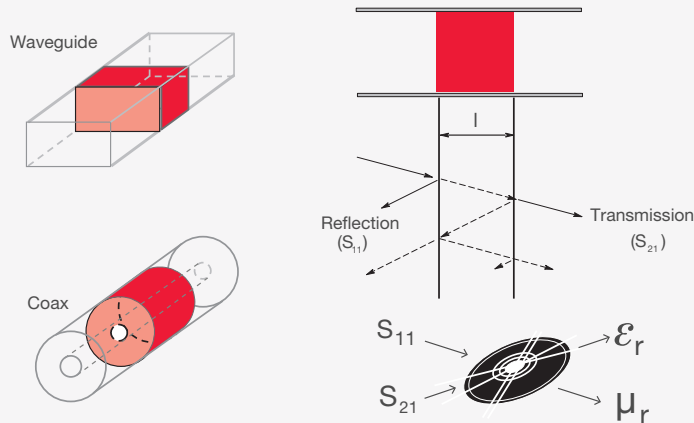
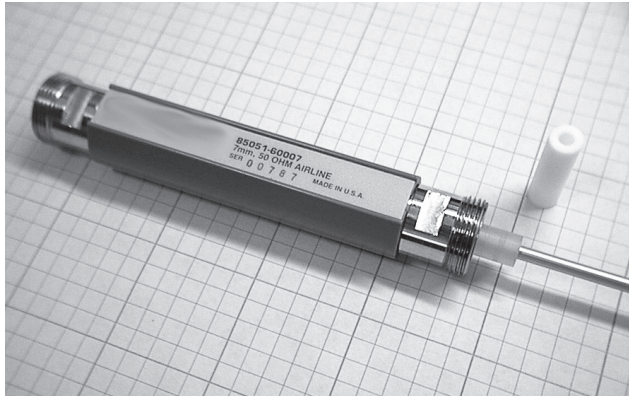
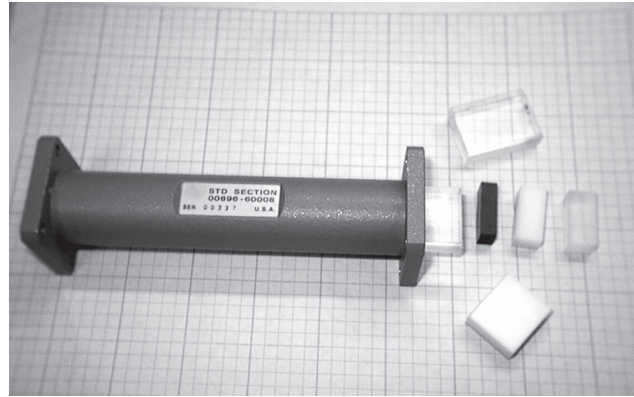

Figure 16. Transmission line method; waveguide and coaxial line case.

Coaxial transmission lines cover a broad frequency range, but a toroid shaped sample is more difficult to manufacture (Figure 17(a)). Waveguide fixtures extend to the mm-wave frequencies and the samples are simpler to machine, but their frequency coverage is banded (Figure 17(b)). A typical measurement system using the transmission line method consists of a vector network analyzer, a coaxial or waveguide transmission line, and software to calculate permittivity and permeability. The software is available in N1500A materials measurement suite. The software can be installed on an external PC and interfaced over GPIB, LAN or USB, depending on the analyzer. Or, with ENA or PNA series network analyzers, the software can be installed directly on the analyzer, eliminating the need for an external PC. Additional information about N1500A materials measurement suite can be found in the Technical Overview⁸ and Software Online Help⁹.



(a)



(b)

Figure 17. Coaxial 7 mm air line with samples (a) and X-band waveguide straight section with samples (b).

The 50 Ohm airline from Keysight verification kits (Figure 17(a)) is the recommended coaxial sample holder. Every waveguide calibration kit in the 11644A family contains a precision waveguide section (Figure 17(b)), recommended for a waveguide sample holder.

Figure 18 shows measurement results of permittivity (a) and loss tangent (b) of two Plexiglas samples with lengths of 25 mm and 31 mm respectively, in an X-band waveguide. The sample holder is the precise waveguide section of 140 mm length that is provided with the X11644A calibration kit (Figure 17(b)). The network analyzer is a PNA, the calibration type is TRL and the precision NIST algorithm⁹ is used for calculation. In both graphs below there are two pairs of traces for two different measurements of the same samples. The top two measurements of each graph are performed for the case when the sample holder is not calibrated out.

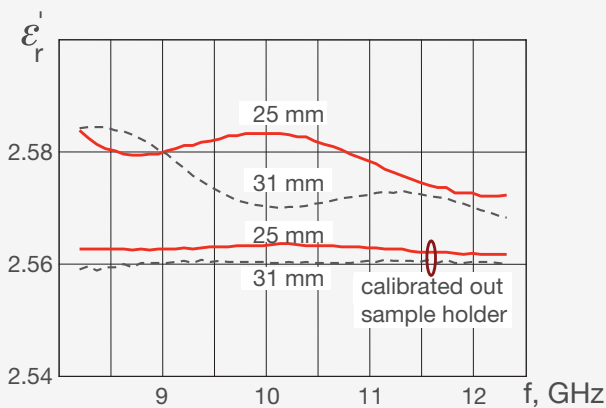

(a)

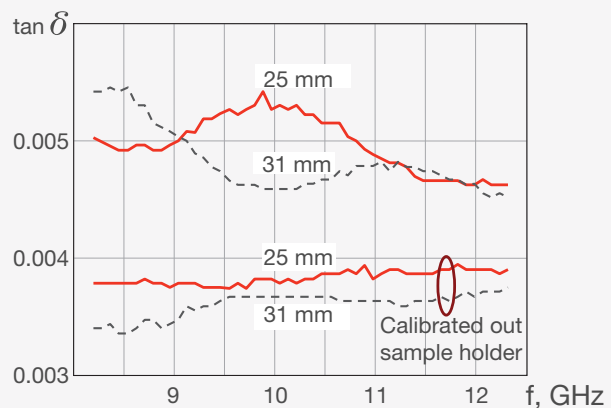

(b)

Figure 18. Measurement of two Plexiglas samples, 25 mm and 31 mm long in a X-band waveguide.

In this case based on the sample length and sample holder length, the N1500A materials measurement suite will rotate the calibration plane correctly to the sample face, but will not compensate for the losses of the waveguide. The bottom two measurements of the same samples are performed for the case when the sample holder is part of the calibration and the waveguide losses and electrical length are calibrated out. As expected, the loss tangent curves (b) show lower values when the sample holder is calibrated out and they are more constant with respect to frequency. This is due to the fact that the waveguide losses are no longer added to the sample's losses. If a sample cannot stand up by itself, for example because it is too thin or in some form other than a rigid solid, it is possible to back it on one or both sides with a dielectric material with known permittivity and thickness. In this case, de-embedding can be used to remove the effects of the dielectric backing from the measurement.

Free space

Material assumptions

- Large, flat, parallel-faced samples
- Homogeneous

Method features

- Non-contacting, non-destructive
- High frequency – low end limited by practical sample size
- Useful for high temperature
- Antenna polarization may be varied for anisotropic materials
- Measures magnetic materials

Free space methods use antennas to focus microwave energy at or through a slab or sheet of material (Figure 19). This method is non-contacting and can be applied to materials to be tested under high temperatures and hostile environments. Figure 19 shows two typical setups: an S-parameter free space transmission configuration (upper) and an NRL arch reflectivity configuration (lower). A typical system consists of a vector network analyzer, appropriate free space fixture and software to calculate permittivity and permeability for the free space transmission method, or reflectivity with the arch method. The software is available in N1500A materials measurement suite. It can be installed on an external PC and interfaced over GPIB, LAN or USB, depending on the analyzer. Or, with ENA or PNA series network analyzers, the software can be installed directly on the analyzer, eliminating the need for an external PC.

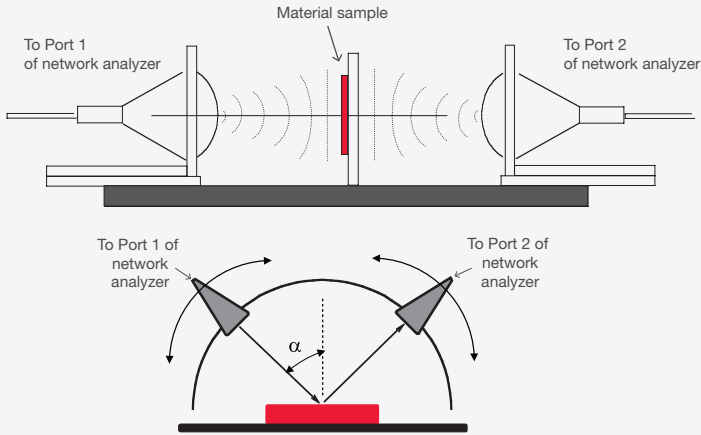

Figure 19. Free space measurement setups.

High temperature measurements are easy to perform in free space since the sample is never touched or contacted (Figure 20). The sample can be heated by placing it within a furnace that has “windows” of insulation material that are transparent to microwaves. Keysight does not provide the furnace needed for such a type of measurement. Figure 20 illustrates the basic set up.

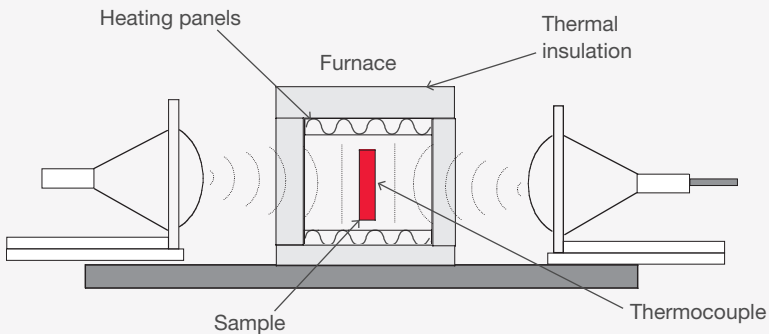

Figure 20. High temperature measurement in free space.

Calibrating the network analyzer for a free space measurement is challenging. Free space calibration standards present special problems since they are “connector-less”. A calibration can be as simple as a response calibration or as complex as a full two-port calibration depending on the convenience and accuracy desired.

The N1500A materials measurement suite offers free space calibration method called GRL (Gated match, Reflect, Line). This calibration routine increases the ease of use and reduces the costs associated with some other calibration methods, such as TRM (Thru, Reflect, Match) and TRL (Thru, Reflect, Line). Use of this option requires a network analyzer with the time domain option, an appropriate free space fixture,

and a metal calibration plate. This option also includes a gated isolation/response calibration, which reduces errors from diffraction effects at the sample edges and multiple residual reflections between the antennas. The N1500A materials measurement suite automatically sets up all the free space calibration definitions and network analyzer parameters, saving engineering time. A guided calibration wizard steps the user through the easy calibration process.

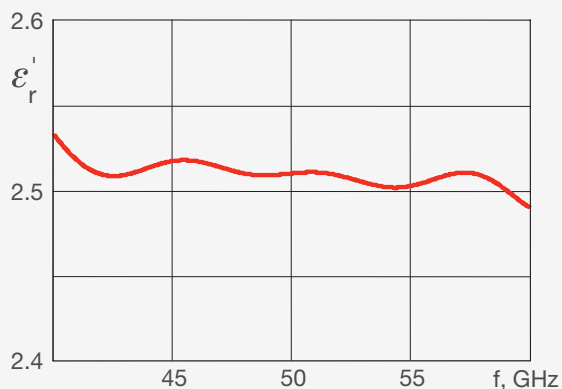

Figure 21. Measurement of Rexolite sample in a U-band (40 – 60 GHz).

Figure 21 depicts the result of a GRL calibration measuring Rexolite material in U-band (40-60 GHz) with a PNA network analyzer and N1500A materials measurement suite. The fixture was made with standard gain horns and a readily available, domestic use, shelving unit to demonstrate that when doing a GRL calibration, even with the simplest set up, it is still possible to perform reasonable measurements. For precise measurements, more rigid fixtures with focused horns are recommended.

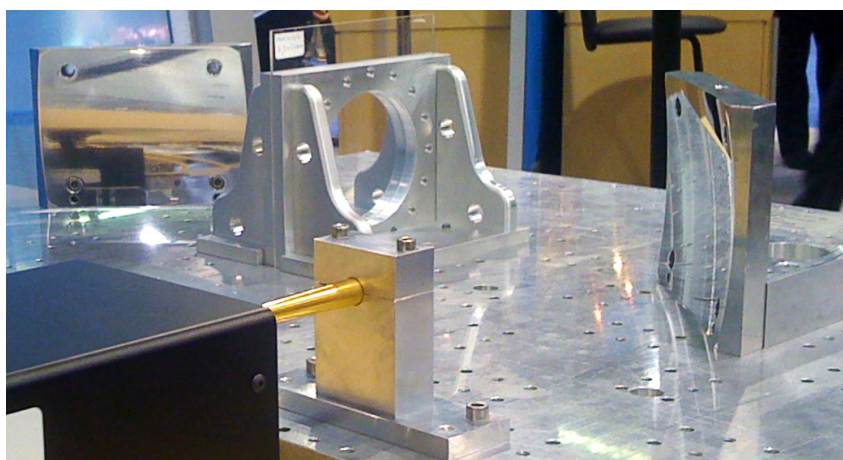

Figure 22. 330-500 GHz Thomas Keating Ltd. Quasi-Optical Table with Gaussian beam horns, focusing mirrors and sample holder.

At mm-wave and submm-wave frequencies, Quasi-Optical Tables are ideal. They can be purchased from Thomas Keating Ltd, or through Keysight Special Handling Engineering. Keysight model numbers:

50 to 110 GHz	Quasi-Optical Table	N1501AE53
60 to 90 GHz	Quasi-Optical Table	N1501AE02
75 to 110 GHz	Quasi-Optical Table	N1501AE01
90 to 140 GHz	Additional Set of Horns	N1501AE22
140 to 220 GHz	Additional Set of Horns	N1501AE23
220 to 325 GHz	Additional Set of Horns	N1501AE18
325 to 500 GHz	Additional Set of Horns	N1501AE24

Additional frequencies, as well as tables covering multiple frequency bands may be available on request.

Resonant cavity

Resonant versus broadband techniques:

Resonant techniques

- High impedance environment
- Reasonable measurements possible with small samples
- Measurements at only one or a few frequencies
- Well suited for low loss materials

Broadband techniques

- Low impedance environment
- Requires larger samples to obtain reasonable measurements
- Measurement at “any” frequency

Resonant cavities are high Q structures that resonate at specific frequencies. A piece of sample material inserted into the cavity affects the resonant frequency (f) and quality factor (Q) of the cavity. From these parameters, the complex permittivity of the material can be calculated at a single frequency. A typical measurement system consists of a network analyzer, a resonant cavity fixture and software to make the calculations.

There are many different methods and types of fixtures. Keysight N1500A materials measurement suite automates three methods: Split Cylinder method, Split Post Dielectric Resonator method and ASTM D2520¹⁰ Cavity Perturbation method. An external computer can be used to control the network analyzer, interfacing over LAN, USB or through GPIB. For the PNA family and the ENA series of network analyzers, the software can be installed directly in the analyzer and there is no need for an external

computer. Keysight also offers high Q resonant cavity fixtures for the Split Cylinder¹³ and Split Post¹⁴ methods.

Split cylinder resonator

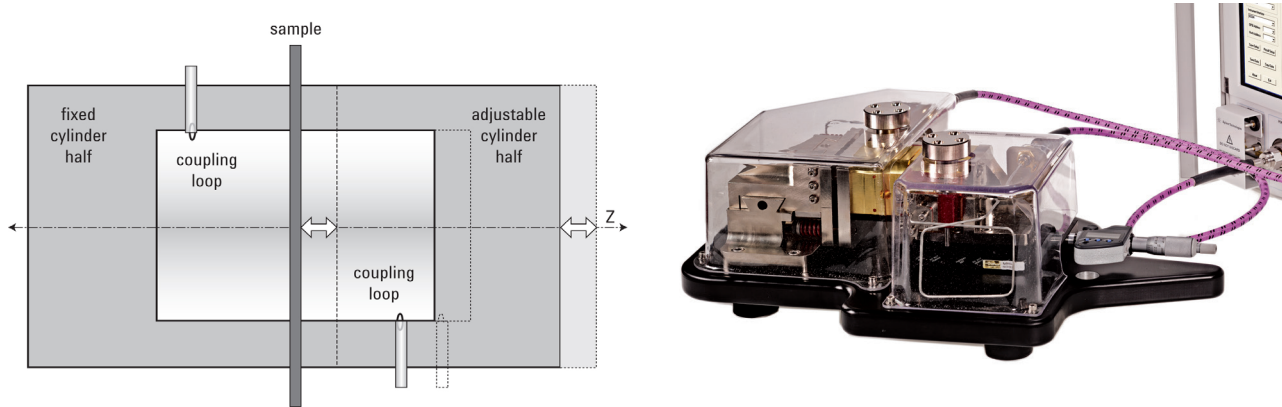

Figure 23. Keysight 85072A 10 GHz split cylinder resonator.

The split cylinder resonator is a cylindrical resonant cavity separated into two halves. The sample is loaded in a gap between the two cylinder halves. One cylinder half is fixed, and the other adjusts allowing the gap to accommodate varying sample thicknesses. The real part of permittivity, ϵ' , and loss tangent or tan delta, $\tan\delta$, are calculated from the sample thickness, cylinder length, and S-parameter measurements of the split cylinder resonator, both empty and loaded with the sample. Using a mode matching model developed at NIST in Boulder, Colorado¹⁴ permittivity and loss tangent can be calculated at the 10 GHz $TE_{0,11}$ mode. It may also be possible to measure at some higher order $TE_{0,np}$ modes₂ where no interfering modes exist. This method was adopted by the IPC as TM-650 2.5.5.13 standard test method.¹⁵

Split post dielectric resonator

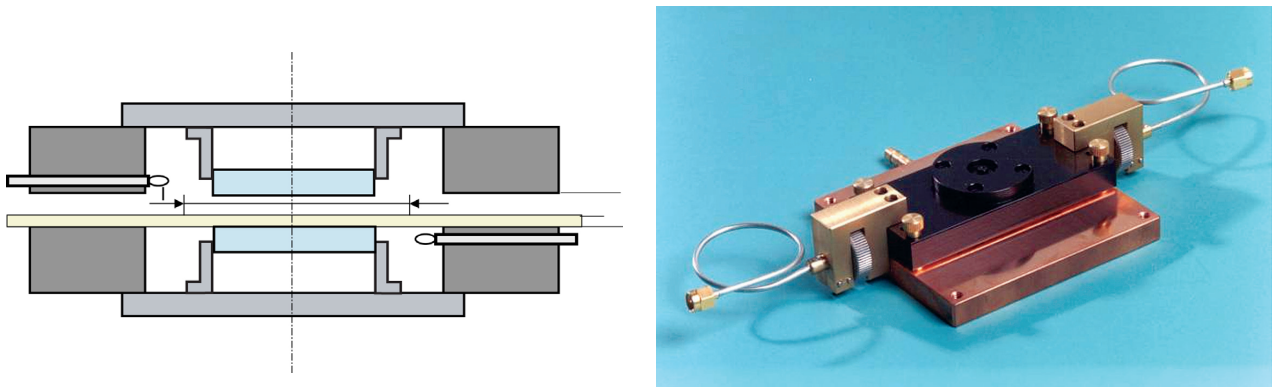

Figure 24. QWED 5 GHz split post dielectric resonator, available from Keysight as N1501AExx.

Split Post Dielectric Resonators from QWED, use low loss dielectric materials which make it possible to build resonators having higher Q-factors and better thermal stability than traditional all-metal cavities. This method is one of the easiest and highest accuracy methods for measuring complex permittivity and loss tangent of low loss and thin sheet materials¹⁶. The relatively inexpensive fixtures can be purchased from QWED or through Keysight Special Handling Engineering in single frequencies from 1 to 15 GHz.

Keysight model numbers:

1.1 GHz	N1501AE19
2.5 GHz	N1501AE03
3.0 GHz	N1501AE13
5.0 GHz	N1501AE04
10.0 GHz	N1501AE10
15.0 GHz	N1501AE15

Additional frequencies may be available on request.

Cavity perturbation (ASTM D2520)

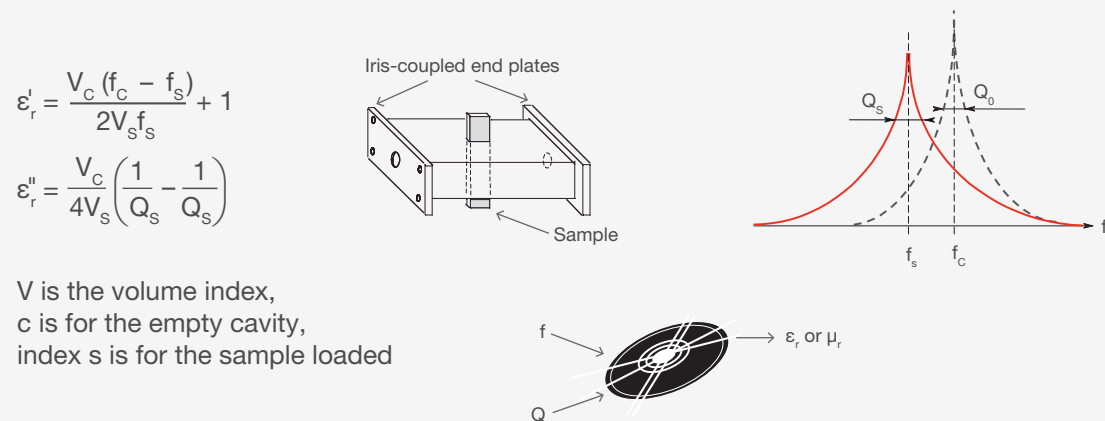

Figure 25. Resonant cavity measurement.

The ASTM 2520¹⁰ cavity perturbation method uses a rectangular waveguide with iris-coupled end plates, operating in TE_{10n} mode (Figure 25). For a dielectric measurement, the sample should be placed in a maximum electric field. Although Keysight does not provide a ready-made resonator fixture for the cavity perturbation method, it is not difficult to adapt a precision waveguide straight section, such as those available in the 11644A series waveguide calibration Kits. A hole needs to be drilled exactly in the middle of the waveguide length and the two iris-coupled end plates need to be manufactured. The dimension of the iris hole is $b/2.2$, where b is the narrow dimension of the waveguide cross section. If the sample is inserted through a hole in the middle

of the waveguide length, then an odd number of half wavelengths will bring the maximum electric field to the sample location, so that the dielectric properties of the sample can be measured. (An even number of half wavelengths will bring the maximum magnetic field to the sample location so that magnetic properties of the sample can also be measured.)

The cavity perturbation method requires a very small sample such that the fields in the cavity are only slightly disturbed to shift the measured resonant frequency and cavity Q. This assumption allows simplifying the theory to use the equations above to calculate the dielectric properties of the material.

Parallel plate

The parallel plate method, also called the three terminal method in ASTM standard D150¹², involves sandwiching a thin sheet of material or liquid between two electrodes to form a capacitor. The measured capacitance is then used to calculate permittivity. In an actual test setup, two electrodes are configured with a test fixture sandwiching dielectric material. The impedance-measuring instrument would measure vector components of capacitance (C) and dissipation (D) and a software program would calculate permittivity and loss tangent. The method works best for accurate, low frequency measurements of thin sheets or liquids. A typical measurement system using the parallel plate method consists of an impedance analyzer or LCR meter and a fixture such as the 16451B and 16453A dielectric test fixture, which operates up to 1 GHz. The 16452A test fixture is offered for measuring liquids. More information about the parallel plate method and other Keysight low frequency materials measurement solutions are available in application note, literature number 5980-2862EN¹ and 380-1¹¹.

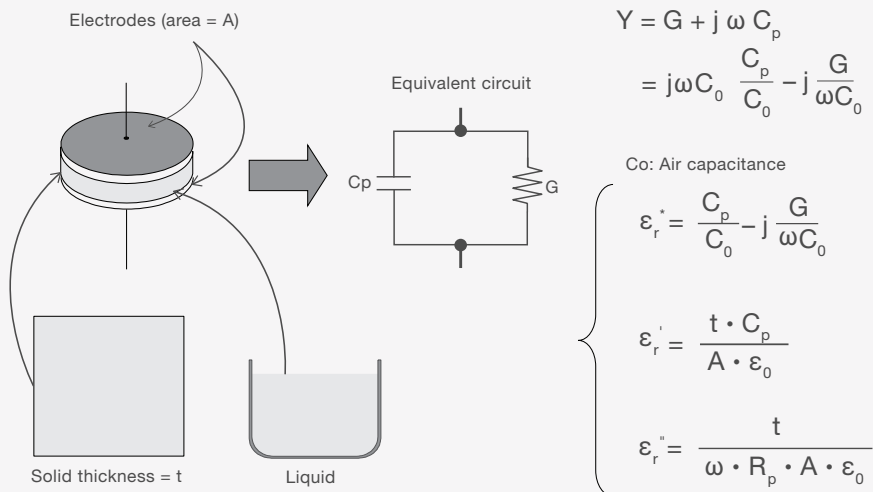

Figure 26. Parallel plate method.



Figure 27. Keysight 16451B and 16453A dielectric test fixture with impedance analyzer.

Inductance measurement method

Relative permeability of magnetic material derived from the self-inductance of a cored inductor that has a closed loop (such as the toroidal core) is often called effective permeability. The conventional method of measuring effective permeability is to wind some wire around the core and evaluate the inductance with respect to the ends of the wire. This type of measurement is usually performed with an impedance analyzer. Effective permeability is derived from the inductance measurement result. The Keysight 16454A magnetic material test fixture provides an ideal structure for single-turn inductor, with no flux leakage when a toroidal core is inserted in it. More information about the inductance measurement method is available in the application note, literature number 5980-2862EN¹.

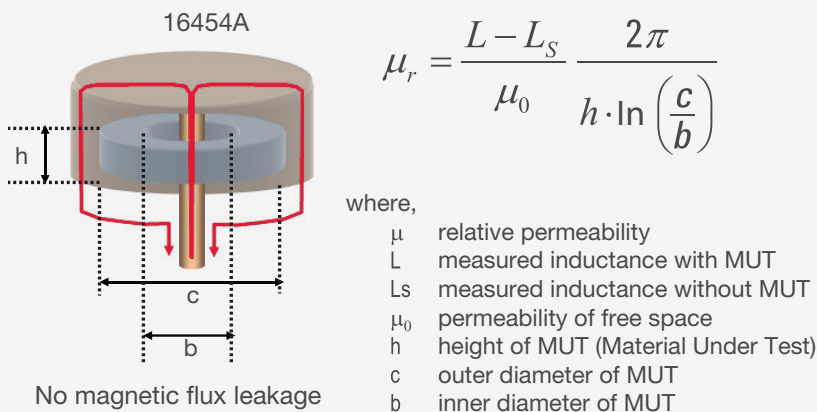

Figure 28. Inductance measurement method.

Comparison of Methods

Many factors such as accuracy, convenience, and the material shape and form are important in selecting the most appropriate measurement technique. Some of the significant factors to consider are summarized here:

- Frequency range
- Expected values of ϵ_r and μ_r
- Required measurement accuracy
- Material properties (i.e., homogeneous, isotropic)
- Form of material (i.e., liquid, powder, solid, sheet)
- Sample size restrictions
- Destructive or nondestructive
- Contacting or non-contacting
- Temperature
- Cost

Figure 29 provides a quick comparison between the measurement methods that have been discussed already.



Coaxial Probe ϵ_r		Broadband, convenient, non-destructive; Best for lossy MUTs; liquids and semi-solids
Transmission Line ϵ_r and μ_r		Broadband Best for lossy to low loss MUTs; machineable solids
Free Space ϵ_r and μ_r		Broadband; Non-contacting Best for flats sheets, powders, high temperatures
Resonant cavity ϵ_r		Single frequency; Accurate Best for low loss MUTs; small samples
Parallel plate ϵ_r		Accurate Best for low frequencies; thin, flat sheets
Inductance measurement μ_r		Accurate, simple measurement, a toroidal core structure is required

Figure 29. Summary of the measurement techniques.

Keysight Solutions

Keysight offers a wide variety of test fixtures to measure the dielectric properties of materials which covers most material types. Figure 30 shows the coverage of Keysight test fixtures depending on material types and frequency ranges.

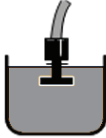
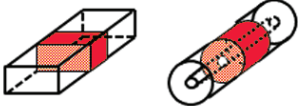
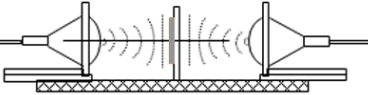
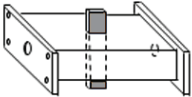
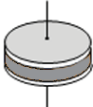
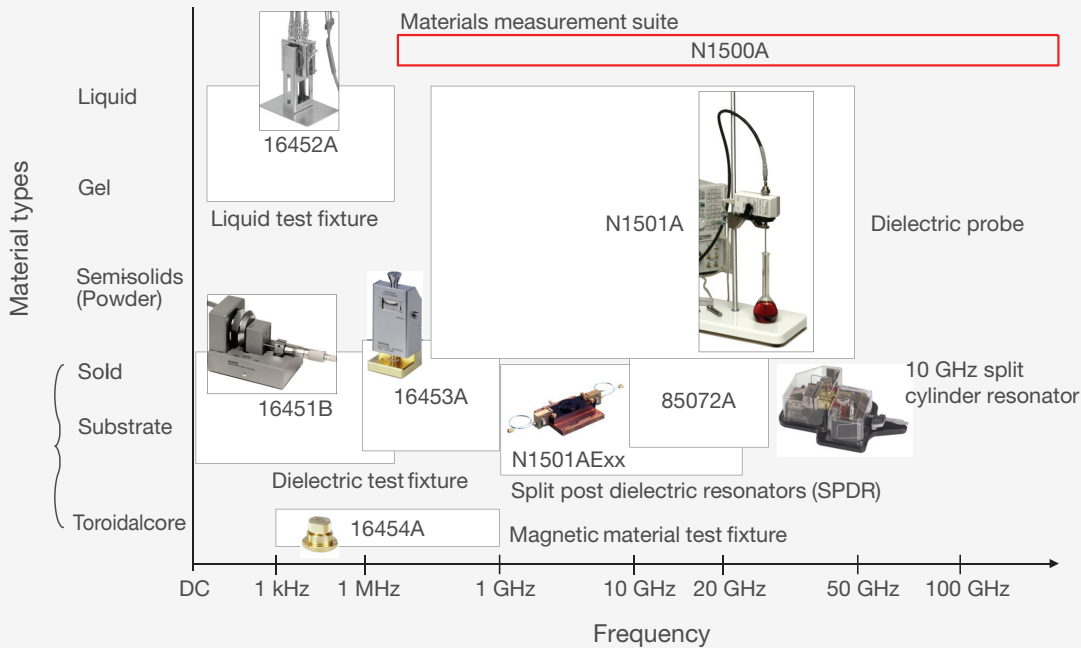

Figure 30. Materials measurement fixtures.

Keysight also offers powerful software to help customers automate complex permittivity and permeability measurement analysis. The N1500A materials measurement suite streamlines the process of measuring complex permittivity and permeability with an Keysight network analyzer. The easy-to-use software guides the user through setup and measurement, instantly converting S-parameter network analyzer data into the data format of your choice and displaying the results within seconds. Results can be charted in a variety of formats:

ϵ_r' , ϵ_r'' , $\tan \delta$, μ_r' , μ_r'' , $\tan \delta_m$ and Cole-Cole

A variety of measurement methods and mathematical models are provided to meet most application needs.

A free space calibration option provides Keysight's exclusive gated reflect line (GRL) calibration for measuring materials in free space. The arch reflectivity option automates popular NRL arch method for measuring reflections off the surface of a sample. The resonant cavity option offers the highest loss tangent accuracy and resolution. The coaxial probe option automates the dielectric probe kit measurements.

Figure 31 summarizes Keysight fixtures and compatible measurement instruments.

		PNA	ENA	FieldFox	E4991B	E4990A	E4980A	4285A	Method
N1501A	Dielectric probe kit	•	•	•	• ¹				Coaxial probe
N1501AExx	Split post dielectric resonators (SPDR)	•	•	•					Resonant cavity
85072A	10 GHz split cylinder resonator	•							Resonant cavity
16451B	Dielectric material test fixture					•	•	•	Parallel plate
16452A	Liquid test fixture					•	•	•	Parallel plate
16453A	Dielectric material test fixture				•				Parallel plate
16454A	Magnetic material test fixture				•	•			Inductance

Figure 31. Keysight instruments and fixtures.

References

1. *Solutions for Measuring Permittivity and Permeability with LCR Meters and Impedance Analyzers*, Application Note, literature number 5980-2862EN
2. *Understanding the Fundamental Principles of Vector Network Analysis*, Application Note, literature number 5965-7707E
3. *Exploring the Architectures of Network Analyzers*, Application Note, literature number 5965-7708E
4. *Applying Error Correction to Network Analyzer Measurements*, Application Note, literature number 5965-7709E
5. D. V. Blackham, R. D. Pollard, *An Improved Technique for Permittivity Measurements Using a Coaxial Probe*, IEEE Trans. on Instr. Meas., vol. 46, No 5, Oct. 1997, pp. 1093-1099
6. *Keysight N1500A Materials Measurement Suite*, Technical Overview, literature number 5992-0263EN

¹ N1501A with E4991B requires N1500A-004 software revision v2014-20150115 and above.

1. *Keysight N1501A Dielectric Probe Kit*, Technical Overview, literature number 5991-0264EN
2. Online Help for N1500A Materials Measurement Suite, <http://na.tm.keysight.com/materials/downloads.html>
3. *ASTM Test methods for complex permittivity (Dielectric Constant) of solid electrical insulating materials at microwave frequencies and temperatures to 1650°*, ASTM Standard D2520, American Society for Testing and Materials
4. *Dielectric constant measurement of solid materials using the 16451B dielectric test fixture*, Application Note, literature number 5950-2390
5. *ASTM, Test methods for A-C loss characteristics and permittivity (dielectric constant) of solid electrical insulating materials*, ASTM Standard D 150, American Society for Testing and Materials
6. *Keysight 85072A 10GHz Split Cylinder Resonator, Technical Overview*, literature number 5989-6182EN
7. M.D. Janezic, *Nondestructive Relative Permittivity and Loss Tangent Measurements using a Split-Cylinder Resonator*, Ph.D. Thesis, University of Colorado at Boulder, 2003.
8. *IPC TM-650 2.5.5.13 Relative Permittivity and Loss Tangent Using a Split-Cylinder Resonator*
9. *Split Post Dielectric Resonators for Dielectric Measurements of Substrates*, Application Note, literature number 5989-5384EN
10. *Challenges and Solutions for Material Science/Engineering Testing Applications*, literature number 5992-1182EN

Learn more at: www.keysight.com

For more information on Keysight Technologies' products, applications or services, please contact your local Keysight office. The complete list is available at: www.keysight.com/find/contactus

